

## User Manual

## ARvision-3D

(with FireWire Cameras)



Subject to technical modifications

## **WARNING**

**Before using the ARvision-3D HMD please read carefully these safety instructions.**

**Read this handbook and use the ARvision-3D device in strict accordance in order to prevent any damage to your eye, other injury, loss of visual functions, property damage or death.**

**Children under the age of fifteen may not use this product.**

**We strongly advise you to get familiar with the ARvision-3D device and its capabilities before you use it for the first time.**

---

## Table of Contents

---

<b>Table of Contents</b> .....	<b>3</b>
<b>1 Safety instructions</b> .....	<b>4</b>
1.1 Health concerns .....	4
1.2 General safety hints .....	5
1.3 Warning for electrical products.....	5
<b>2 Content of the ARvision-3D Kit</b> .....	<b>6</b>
<b>3 Description</b> .....	<b>7</b>
3.1 Head Mounted Display HMD .....	7
3.2 Power unit .....	8
<b>4 General Operating Instructions</b> .....	<b>9</b>
4.1 Preparation .....	9
4.2 Connecting external video sources .....	10
4.3 Putting on the ARvision-3D.....	11
4.4 Adjusting the Interpupil Distance .....	12
4.5 On-Screen-Display Menu (OSD) .....	13
4.6 Adjusting Brightness, Contrast and VGA Phase (OSD) .....	14
4.7 Using different Stereo Modes .....	15
4.8 Adjusting the image (Software).....	16
4.9 FireWire-Camera / Software.....	17
4.10 AR setup .....	17
4.11 Firmware update .....	19
<b>5 Maintenance and Cleaning Instructions</b> .....	<b>21</b>
<b>6 Troubleshooting</b> .....	<b>22</b>
<b>7 Returning used electronic devices in EU countries</b> .....	<b>23</b>
<b>8 Technical Data</b> .....	<b>24</b>
8.1 Head Mounted Display .....	24
8.2 Power unit .....	25

---

## 1 Safety instructions

---

---

### 1.1 Health concerns

---

➔ **WARNING:** Eye Disease, Eye Injury, and Glaucoma

If you have been diagnosed with or are susceptible to eye disease, eye injury, or glaucoma consult your doctor before use and do not use without your doctor's approval.

➔ **CAUTION:** Heart Disease, High Blood Pressure

If you have a history of heart disease or high blood pressure consult your doctor before use and do not use without his approval.

➔ **CAUTION:** Seizures

If you have a history of temporary spasm, unconsciousness, or epileptic seizures from light stimulation, consult your doctor before use and do not use without his approval.

If any of the following symptoms occur, if using ARvision-3D, stop using immediately and rest:

- eye fatigue or irritation,
- headaches or dizziness,
- aches and pain in the neck or shoulders,
- double vision,
- nausea or motion sickness,
- inability to focus on the displays.

Misuse or overuse of this product may result in eye damage, or loss of visual functions.

---

## **1.2 General safety hints**

---

- ➔ Avoid getting the cable entangled around your neck, body or arms. Use the belt pouch for the power unit and wear the cable close to your body.
- ➔ To ensure that the device does not fall off during use, always use the elastic strap, and have it tightened with an adequate tension.

---

## **1.3 Warning for electrical products**

---

- ➔ To avoid any risk of electrocution, do not bring any part of the ARvision-3D in contact with water when the power unit is connected to an AC outlet (e.g. when recharging batteries, using an external TV-, DVD-, Video- or PC-source).
- ➔ Avoid using and storing the ARvision-3D at wet, humid, dusty and smoky surroundings and extreme temperatures.
- ➔ Do not use ARvision-3D at temperatures below -10°C and above +40°C. Avoid dropping or mechanical shock, as frame and displays may be deformed.
- ➔ Always switch off and unplug the ARvision-3D when it will not be used.
- ➔ In case of damage contact your retailer. There are no user serviceable parts. Only qualified service personnel should perform any service required on this product.

---

## 2 Content of the ARvision-3D Kit

---

The ARvision-3D kit contains the following elements. Please check that all of these are included. If any item is not supplied contact your ARvision-3D dealer.

ARvision-3D HMD with connecting cable (1), Power unit (2), AC/DC transformer (3), Cleaning cloth (4), FireWire-Cable (5) 2pcs for splitted version, DVI-Cable (6), USB-cable (7), Driver-CD(9)

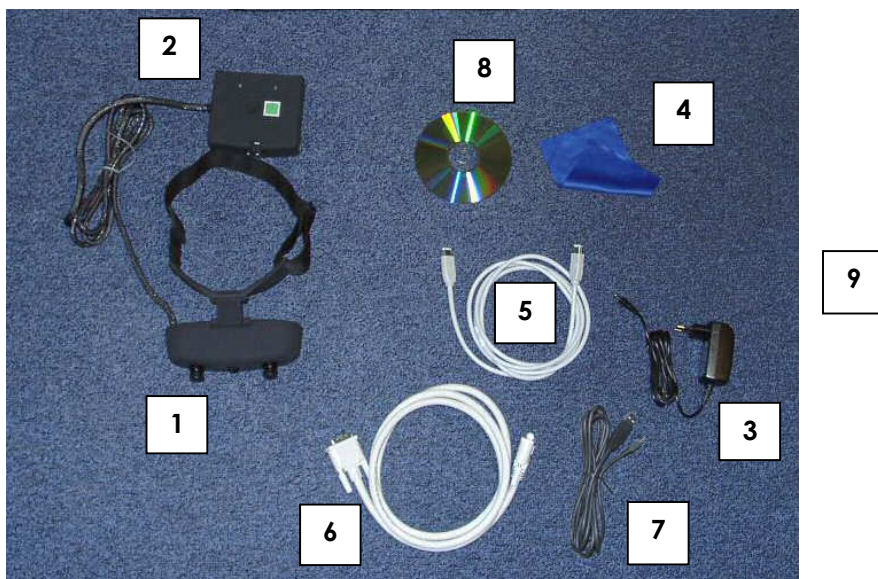

---

### 3 Description

---

---

#### 3.1 Head Mounted Display HMD

---

The HMD contains two **microdisplays** (2) to show the images. The **cable** (1) is permanently attached to the HMD and to the pocket element (power unit). The built-in color camera (3) provides the video signal to the power unit for output to a PC. Without a PC or external video source connected to the power unit there is no image visible inside the HMD !

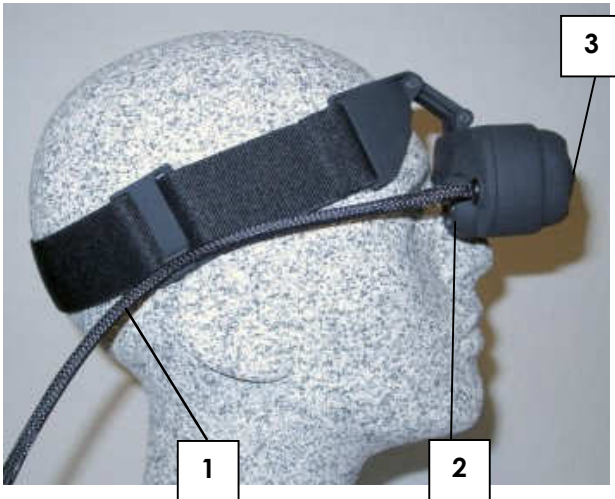

---

## 3.2 Power unit

---

The plastic casing contains the following elements:

- (1) HMD cable permanently attached
- (2) Plug connections for FireWire camera cables
- (3) Plug connections for PC (DVI and VGA)
- (4) Push button for power (illuminated)
- (5) Connector for power supply
- (6) Joystick for manual adjustments
- (7) Indicating LEDs
- (8) USB connection for image adjustments and firmware updates

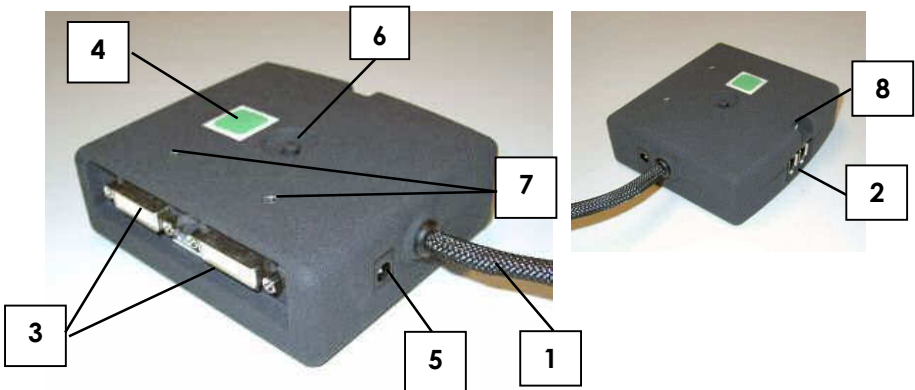

The **push button** (4) on the top of the power unit is used to switch the ARvision-3D on and off. When the device is switched on, a light underneath the button lights up. For switching on/off the button must be pressed more than 1 second (see further).

---

## 4 General Operating Instructions

---

---

### 4.1 Preparation

---

#### Unpacking the Device

- ➔ Please unpack the devices and compare with the list under paragraph 2 on page 6 to check that all parts are complete. Please contact your dealer if any parts are missing.

#### Using the HMD with external power supply

Please use only the AC/DC transformer that comes with the device. Its output is 12 V DC, available at the special plug. This plug (see also(5) page 8) fits into the connector at the power unit.



An external battery pack will be available soon.

---

## 4.2 Connecting external video sources

---

You can either connect the device by one or two DVI cables or by one or two VGA cables using additional DVI to VGA adapter (1). The device will automatically recognize the correct signal. Input1 (IN1) and input2 (IN2) can independently receive DVI or VGA in 800x600 at 60Hz or 100Hz. The last used input channel is memorized. The indicating LEDs (2) will show the status (on=signal, slow flashing=no signal, fast flashing=active stereo, off=channel is not active).

A static image can burn into the microdisplays after an extended period of time !

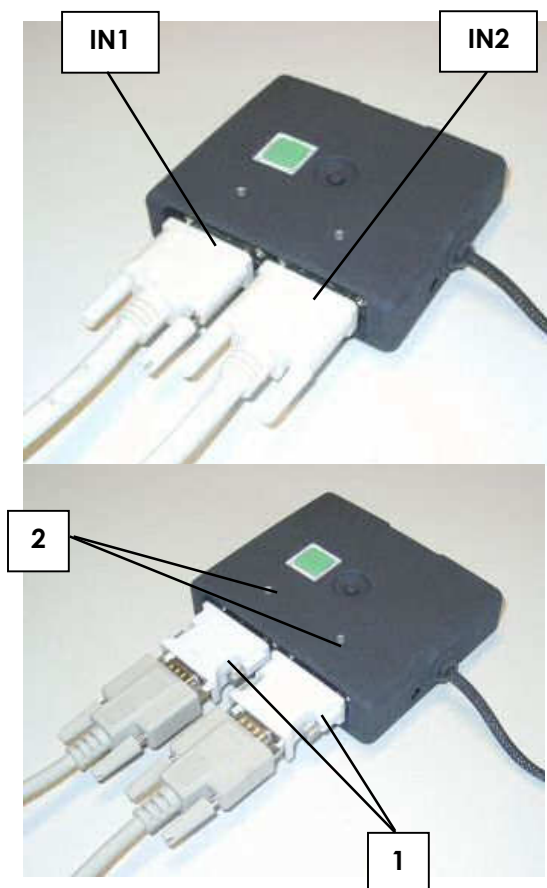

---

### 4.3 Putting on the ARvision-3D

---

#### Putting on the HMD

- ➔ Put on the ARvision HMD. Place the headband around the back of your head and pull it just tight enough to make it fit safely and comfortably.
- ➔ On the displays inside the HMD, you can now see the pictures of your video sources.
- ➔ Wearing the HMD you will see your surroundings only constricted. For this reason, please, move only carefully or not at all.

---

#### 4.4 Adjusting the Interpupil Distance

---

To optimize the position of the two displays, so that both images are seen as a single visual field, carefully move the oculars into the right position.

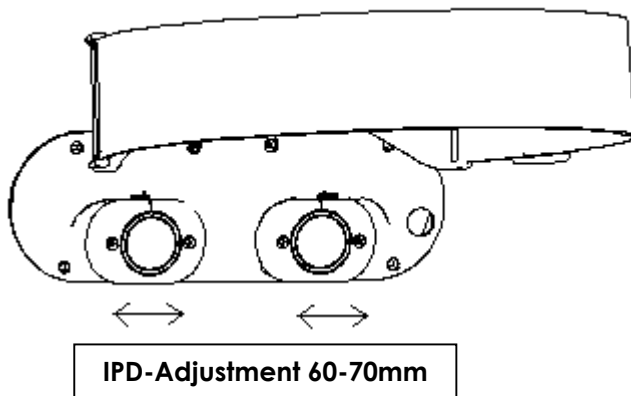

---

## 4.5 On-Screen-Display Menu (OSD)

---

### Using the joystick

Push the joystick to activate the OSD. Then you can navigate in menu by moving the joystick left/right or up/down. To exit the menu the joystick must be pushed again. You can change the joystick orientation, choosing it's UP direction in the menu.

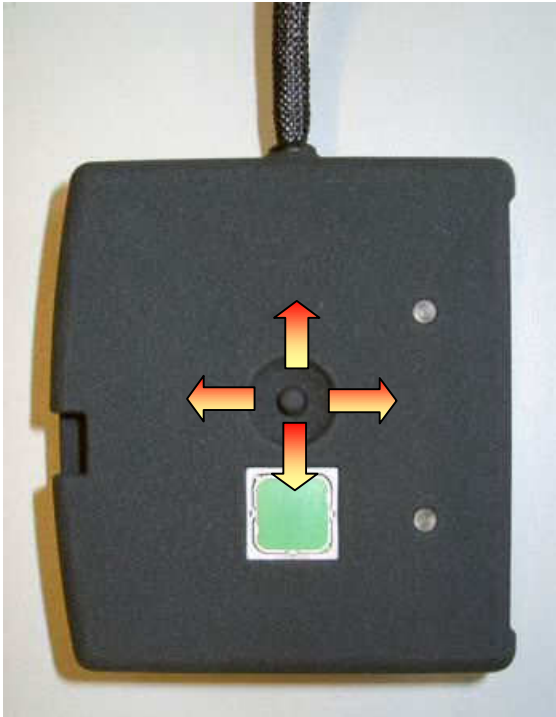

---

## 4.6 Adjusting Brightness, Contrast and VGA Phase (OSD)

---

First select the input channel IN1 or IN2 for left or right eye. Option "Both" can be used for passive stereo signals (see also page 15).

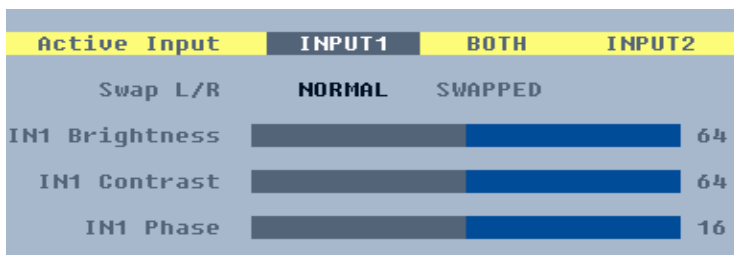

Then you can adjust the brightness, contrast and phase of VGA signal for both eyes independently.

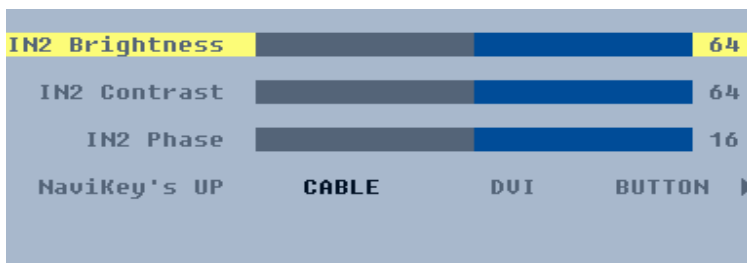

---

## 4.7 Using different Stereo Modes

---

The electronics of your ARvision-3D device allows two different stereo modes. The electronic is automatically detecting when active stereo signal is supplied by the graphics card of PC. To switch between monoscopic and passive stereo mode please select both input channels in OSD (see page 14).

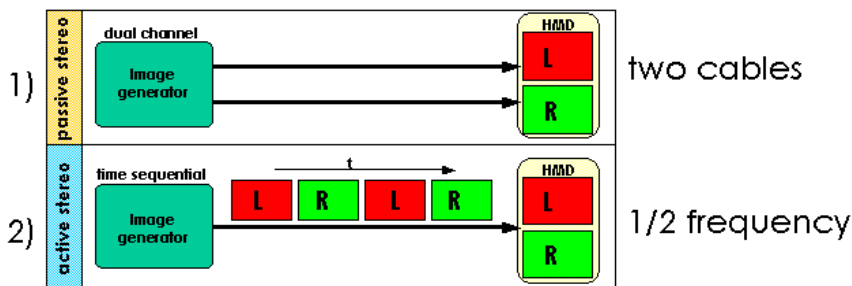

---

## 4.8 Adjusting the image (Software)

---

Please install **first** the software from CD-ROM according instructions **before** you connect the power unit with the PC using the USB-cable. After installation process plug in the USB cable to the power unit and turn on the device. Windows will detect the hardware and install automatically. To adjust the image start the software "hmd\_connection.exe" either from icon or start menu. Then select the HMD (also serial number is shown here). Then you can go to menu "Picture" and adjust the brightness, contrast and gamma of the image. You can also change the look-up table (LUT) or flip the image.

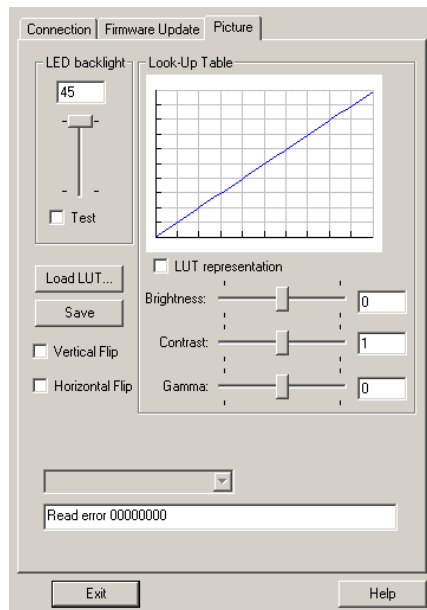
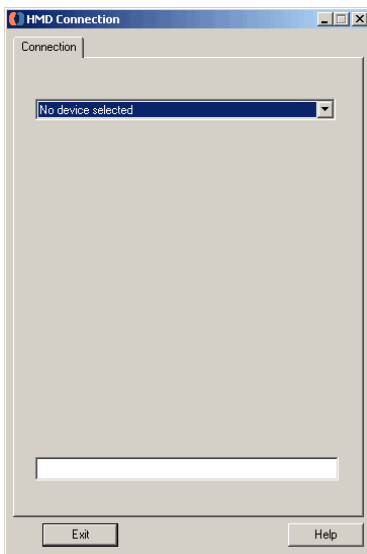

---

## 4.9 FireWire-Camera / Software

---

Please install **first** the software from CD-ROM according instructions **before** you connect the power unit with the PC using the FireWire-cables. Then power on the device and Microsoft Windows® will recognize new hardware automatic. To check both FireWire cameras you can run the FlyCap software twice. **To avoid damage (and to prevent aging) please unplug the FireWire-cable between powerunit and PC during lightning storm and when unused for long periods of time.**

---

## 4.10 AR setup

---

To use the device with AR function (augmented reality) the camera signal must be sent to a computer using two standard FireWire cables (1)). Then the overlaid stereoscopic video signal from the PC can be directed into the power unit using one or two DVI or VGA-cables (2). The PC-resolution must be set to 800x600@60Hz or @100Hz.



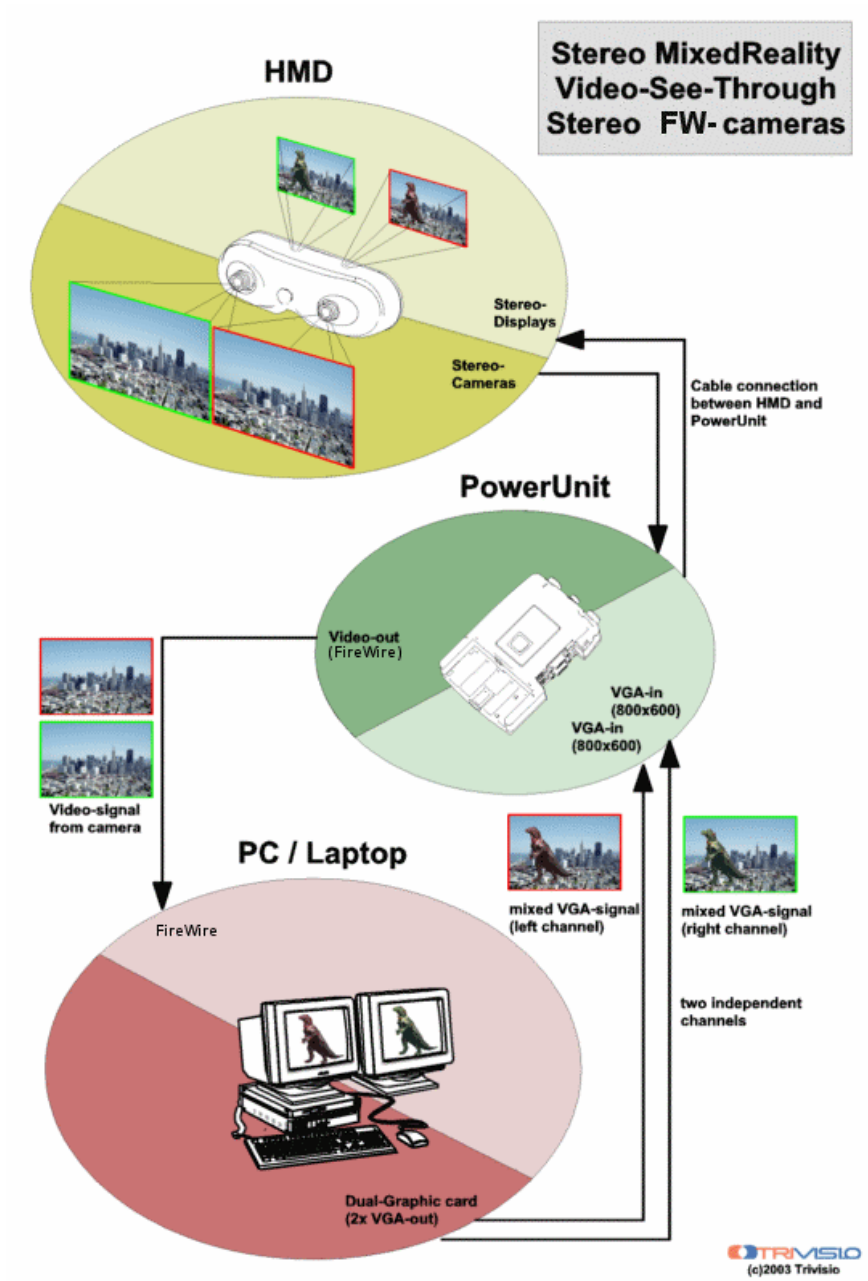

---

## 4.11 Firmware update

---

In the need of a firmware update connect the device be an USB cable to the PC and turn on the device. Then run HMD-software "hmd\_connection.exe" and chose the menu of new firmware. Select the fimrware file by clicking on "Browse". The firmware is provided as "RIGHT\_0x000?.hex" and "LEFT\_VGA\_DVI\_0x000?.hex" files. Then click "Program". You should program these files one by one in above mentioned order. After programming the last file the device will turn off automatically. **During the update process never unplug the device and do not shut down the computer and do not turn off the power !** If the device fails to turn on, try to reprogram "LEFT\_VGA\_DVI\_0x000?.hex" file, holding power-button pushed during programming process.

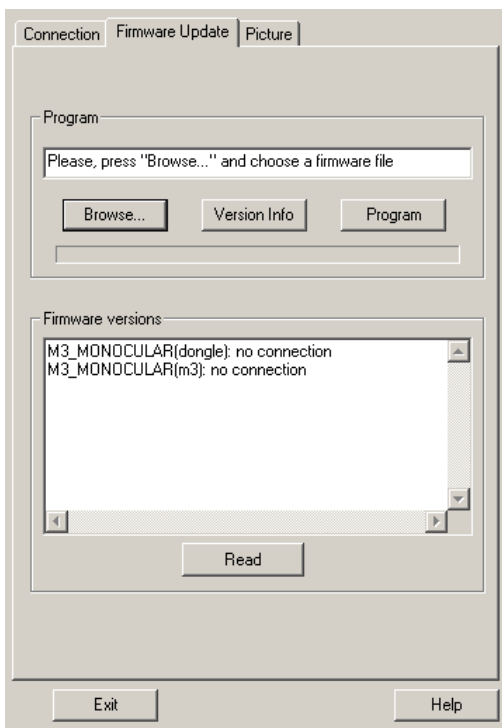

## Adjusting cameras

For adjusting the convergence use the wheel (1). The focus can be manually adjusted by turning the camera lenses (2).

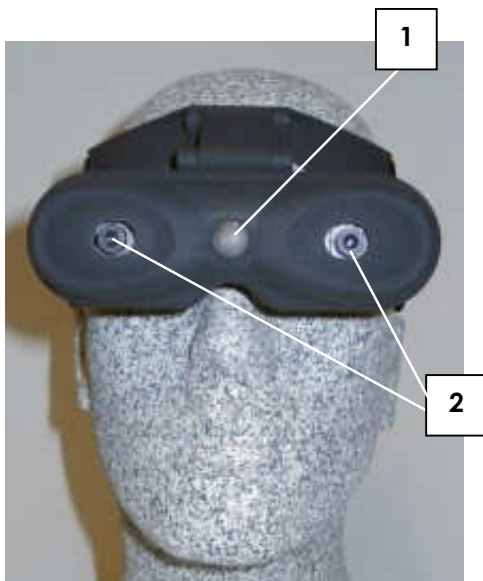

---

## **5 Maintenance and Cleaning Instructions**

---

To clean the HMD and control unit, use a damp cloth. A light rinsing agent may be added to the water. Do not use any detergents.

To clean the oculars of the HMD use a dry, clean cloth. A cleaning cloth for this purpose is provided with the ARvision-3D kit.

In case of damage contact your retailer. There are no user serviceable parts. Only qualified service personnel should perform any service required on this product.

---

## 6 Troubleshooting

---

<b>Problem</b>	<b>Cause</b>	<b>Remedy</b>
<b>Only dark, or only white image</b>	Incorrect brightness.	See OSD or software and adjust correct
<b>No image</b>	In basic mode and no VGA or DVI signal applied	Connect a video source (SVGA)
<b>No image</b>	Device was used on the other input channel before	Push joystick and select input channel manually or swap cable
<b>No image</b>	Appliance switched off	Switch on ARvision-3D with main push button (>1 sec)
<b>Unsharp image</b>	Focus of camera lens is not adjusted	Adjust the focus by turning the camera lens

**All other problems should be performed by a trained and authorised service provider !**

---

## 7 Returning used electronic devices in EU countries

---

	<p>This HMD and accessories shall not be treated as household waste. The separate collection is a condition for reuse, recycling and utilisation of used electronic devices, which ensures the protection of resources. To comply with german ElektroG (Rücknahme und Entsorgung von Elektro- und Elektronikaltgeräten) and european WEEE (Waste Electrical and Electronic Equipment) electronic used devices from private households can be returned free of charge. For details please contact your local distributor or directly Trivisio Prototyping GmbH (<a href="http://www.trivisio.com">www.trivisio.com</a>).</p>
---	---

---

## 8 Technical Data

---

---

### 8.1 Head Mounted Display

---

Camera.....	752x480 pixels color 8 & 16bit, 60 fps, 400 Mbit/sec 1/3"CMOS
Focus.....	manually adjustable
Iris.....	fixed
Camera lens.....	52° (changeable)
Display .....	2x SVGA microdisplays 480,000 color pixels 100 Hz, 120Hz
Field of view .....	approx. 40° diagonal
Eye distance.....	60-70 mm adjustable
Operating temperature.....	-10°C to +40°C
Weight .....	220g
Dimensions (W/H/D).....	155mm/50mm/65mm

---

## 8.2 Power unit

---

Brightness .....	manually adjustable
Contrast .....	manually adjustable
Gamma.....	manually adjustable
Input Signal.....	DVI-D or VGA, 800x600 pixel color at 60Hz or 100Hz
Modes.....	2 stereo modes (passive and active), 1 monoscopic mode
Weight .....	185 g
Dimensions (W/H/D).....	100mm/35mm/110mm
Operating temperature.....	-10°C to +40°C